

# SMITH CARREL, INC.



Call Toll Free 1-877-410-6994 or Fax 972-272-7208

## Sit Stand Training Carrels



**Model #01838K Sit Stand Training Carrel in Bannister Oak  
30" X 48"**

The Training Carrel is standard with a full width cable management tray, 5" high and 3 1/4" deep steel, and (2) wiring grommets. The work surface is high pressure laminate supported by a 14-gauge black powder coated heavy duty frame. The height of the work surface is adjustable from 30" sitting to 40" standing height in 1" increments. Will support 300+ pounds. ADA Compliant. CPU Holders, Keyboard Trays and other accessories are available. See below.

 Click on any photo to enlarge!  
 **Print this page!**

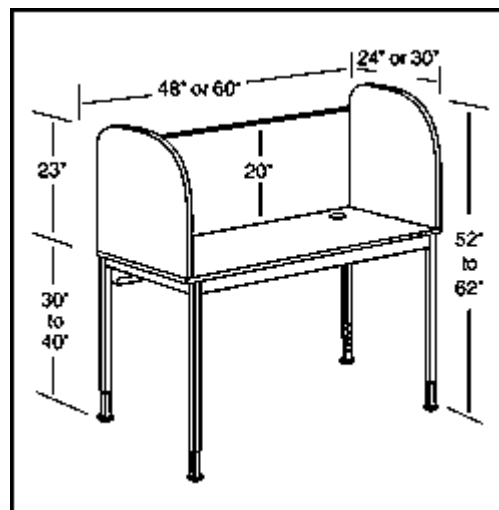

**Sit Stand Carrel Dimensions**

**Overall:  
24" or 30"D x  
48" or 60"W x  
adj. 46"-62"H**

Freight Class: 70  
Shipping Location: 75042

**MODEL NUMBERS**  
*Available as a starter only!*

<b>01828 Carrel - 24"D x 48"W</b>	
Weight:	<b>116</b>
Cube:	<b>4.49</b>
<b>01829 Carrel - 30"D x 48"W</b>	
Weight:	<b>130</b>
Cube:	<b>5.28</b>

<b>01838 Carrel - 24"D x 60"W</b>	
Weight:	<b>132</b>
Cube:	<b>5.10</b>
<b>01839 Carrel - 30"D x 60"W</b>	
Weight:	<b>149</b>
Cube:	<b>6.04</b>



Click on any photo to enlarge!



**Print this page!**



**Model #01829D Sit Stand Training Carrel in Grey Nebula  
24" X 60"**

**Color Choices**

**Add color suffix to model number**

Feet or lower legs of adjustable models are always chrome.

<b>Specify Suffix</b>	<b>Panels</b>	<b>Work Surface</b>	<b>Corner Post Legs</b>
<b>D</b>	BLACK / SAND	GREY NEBULA	BLACK
<b>K</b>	BLACK / SAND	BANNISTER OAK	BLACK

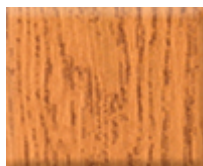

**Grey Nebula    Bannister Oak**

*Actual colors may vary*

**Product Specifications - Sit Stand Training Carrels**

**Surface and Panels**

Are 3/4" thick solid core construction in low glare thermofused melamine laminate with PVC edge banding. Side panels have curved corners for aesthetic appeal. Equipped with (2) 3" diameter cable grommets for wiring. The work surface front edge is 3mm soft radius PVC for arm comfort.

**Frame**

Includes four 1 1/4" square 14-gauge steel corner post legs with black baked on powder coat finish. Legs are equipped with 1" square 14-gauge adjustable leg stems that allow the work surface to be moved in 1" increments from the height of 30" to a height of 40". Legs also include 1" leveling glides for a firm level fit to the floor. Ships ready to assemble.

**Accessories for Sit Stand Training Carrels**

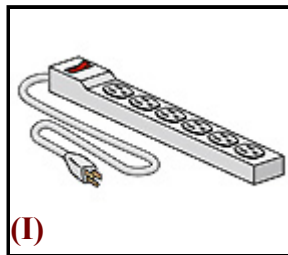
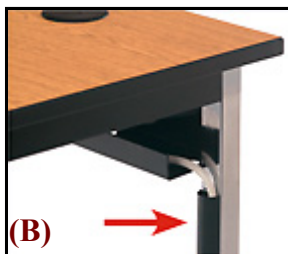
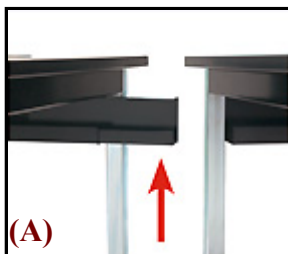



Model	Accessory Description	Wt.	Cube
<b>(A) 01522</b>	Wiring Bridge / Black Powder Coat	2	.05
<b>(B) 01523</b>	"D" Cord Management Plastic Extrusion	1	.02
<b>(C) 01524</b>	2 3/8" x 18" Tie Plate - Black Powder Coat (secures adjacent tables together)	1	.02
<b>(D) 01526</b>	Set of (4) ADA 25" - 35" Leg Inserts	6	.61
<b>(E) 01527</b>	25-1/2"W x 11-3/4"D Keyboard/Mouse Tray	11	1.30
<b>(G) 01531</b>	CPU Holder for 24" or 30" deep units - adjustable to any size CPU	7	.65
<b>(H) 01530</b>	20"W x 11-3/4"D Keyboard Tray	10	1.11
<b>(I) 01650</b>	6 Outlet Surge Protected Power Strip	2	.10
<b>(L) 01532</b>	Power Module w/ 10' Power Cord	2	.10

Info & Support: [info@smithcarrel.com](mailto:info@smithcarrel.com)

[Home](#)

Sales: [sales@smithcarrel.com](mailto:sales@smithcarrel.com)

© 2008-15 Smith Carrel, Inc. All rights reserved. [Terms of Use](#)  
 (NOTE: Computers and related equipment and photo props are not included.)